

INSPIRON™

SETUP GUIDE



INSPIRON™

SETUP GUIDE

Model PP25L

Notes, Notices, and Cautions



NOTE: A NOTE indicates important information that helps you make better use of your computer.



NOTICE: A NOTICE indicates either potential damage to hardware or loss of data and tells you how to avoid the problem.



CAUTION: A CAUTION indicates a potential for property damage, personal injury, or death.

Information in this document is subject to change without notice.

© 2008 Dell Inc. All rights reserved.

Reproduction of these materials in any manner whatsoever without the written permission of Dell Inc. is strictly forbidden. Trademarks used in this text: *Dell*, the *DELL* logo, *Inspiron*, *YOURS IS HERE*, and *DellConnect* are trademarks of Dell Inc.; *Intel*, *Pentium*, and *Celeron* are registered trademarks and *Core* is a trademark of Intel Corporation in the United States and other countries; *Microsoft*, *Windows*, and *Windows Vista* are either trademarks or registered trademarks of Microsoft Corporation in the United States and/or other countries.; *Bluetooth* is a registered trademark owned by Bluetooth SIG, Inc. and is used by Dell under license.

Other trademarks and trade names may be used in this document to refer to either the entities claiming the marks and names or their products. Dell Inc. disclaims any proprietary interest in trademarks and trade names other than its own.

This product incorporates copyright protection technology that is protected by method claims of certain U.S. patents and other intellectual property rights owned by Macrovision Corporation and other rights owners. Use of this copyright protection technology must be authorized by Macrovision Corporation, and is intended for home and other limited viewing uses only unless otherwise authorized by Macrovision Corporation. Reverse engineering or disassembly is prohibited.

Contents

Setting Up Your Inspiron Laptop	5	Media Controls	19
Before Setting Up Your Computer	5	Display Features	20
Connect the AC Adapter	6	Removing and Replacing the Battery	21
Check the Wireless Switch	6	Using the Optical Disc Drive	22
Connect the Network Cable (optional)	7	Software Features	23
Press the Power Button	7	Network Problems	25
Windows Vista® Setup	8	Solving Problems	25
Connect to the Internet (Optional)	8	Power Problems	26
Using Your Inspiron Laptop	12	Memory Problems	28
Device Status Lights	12	Lockups and Software Problems	28
Right Side Features	14	Dell Support Center	31
Left Side Features	16	Using Support Tools	31
Front Side Features	17	System Messages	32
Computer Base and Keyboard Features	18	Hardware Troubleshooter	33
		Dell Diagnostics	34

Restoring Your Operating System	36	Finding More Information	
System Restore	36	and Resources	48
Dell Factory Image Restore	38	Basic Specifications	50
Operating System Reinstallation	39	Index	59
Getting Help	41		
Technical Support and			
Customer Service	42		
DellConnect™	42		
Online Services	42		
AutoTech Service.....	43		
Product Information.....	44		
Returning Items for Repair			
Under Warranty or for Credit	44		
Before You Call.....	45		
Contacting Dell.....	46		

Setting Up Your Inspiron Laptop

This section provides information about setting up your Inspiron 1318 laptop and connecting peripherals.

Before Setting Up Your Computer

When positioning your computer, ensure that you allow easy access to a power source, adequate ventilation, and a level surface to place your computer.

Restricting airflow around your Inspiron computer may cause it to overheat. To prevent overheating ensure that you leave at least 10.2 cm (4 in) at the back of the computer and a minimum of 5.1 cm (2 in) on all other sides. You should never put your computer in an enclosed space, such as a cabinet or drawer when it is powered on.



NOTICE: Placing or stacking heavy or sharp objects on the computer may result in permanent damage to the computer.

Connect the AC Adapter

Connect the AC adapter to the computer and then plug it into a wall outlet or surge protector.

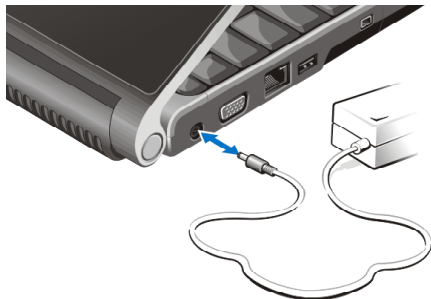

⚠ CAUTION: The AC adapter works with electrical outlets worldwide. However, power connectors and power strips vary among countries. Using an incompatible cable or improperly connecting the cable to a power strip or electrical outlet may cause fire or equipment damage.

Check the Wireless Switch

If you plan to use wireless connections, make sure the wireless switch is in the "On" position.



Using The Wireless Switch

To turn on the wireless switch, slide it from the rear to the front of the computer until it clicks into place.



Connect the Network Cable (optional)

If you plan to use a wired network connection, plug in the network cable.

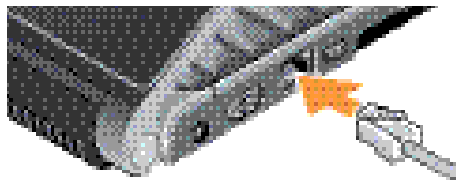

Press the Power Button



Windows Vista® Setup

Your Dell computer is preconfigured with Windows Vista. To set up Windows Vista for the first time, follow the instructions on the screen. These steps are mandatory and may take up to 15 minutes to complete. The screens will take you through several procedures including accepting license agreements, setting preferences and setting up an Internet connection.

 **NOTICE:** Do not interrupt the operating system's setup process. Doing so may render your computer unusable.

Connect to the Internet (Optional)

 **NOTE:** ISPs and ISP offerings vary by country.

To connect to the Internet, you need an external modem or network connection and an Internet service provider (ISP). Your ISP will offer one or more of the following Internet connection options:

- DSL connections that provide high-speed Internet access through your existing telephone line or cellular telephone service. With a DSL connection, you can access the Internet and use your telephone on the same line simultaneously.
- Cable modem connections that provide high-speed Internet access through your local cable TV line.
- Satellite modem connections that provide high-speed Internet access through a satellite television system.

- Dial-up connections that provide Internet access through a telephone line. Dial-up connections are considerably slower than DSL and cable (or satellite) modem connections. Your computer does not have an integrated modem. An optional USB modem must be used for dialup service with this computer.
- Wireless LAN connections that provide Internet access using WiFi 802.11 technology. Wireless LAN support requires optional internal components that may or may not be installed in your computer based on decisions made at the time of purchase.

 **NOTE:** If an external USB modem or WLAN adapter is not part of your original order you can purchase one from the Dell website at dell.com.

Setting Up a Wired Internet Connection

If you are using a dial-up connection, connect the telephone line to the external USB modem (optional) and to the telephone wall jack before you set up your Internet connection. If you are using a DSL or cable/satellite modem connection, contact your ISP or cellular telephone service for setup instructions.

Setting Up a Wireless Connection

Before you can use your wireless Internet connection, you need to connect to your wireless router. To set up your connection to a wireless router:

1. Save and close any open files, and exit any open programs.
2. Click **Start**  → **Connect To**.
3. Follow the instructions on the screen to complete the setup.

Setting Up Your Inspiron Laptop

Setting Up Your Internet Connection

To set up an Internet connection with a provided ISP desktop shortcut:

1. Save and close any open files, and exit any open programs.
2. Double-click the ISP icon on the Microsoft® Windows® desktop.
3. Follow the instructions on the screen to complete the setup.

If you do not have an ISP icon on your desktop or if you want to set up an Internet connection with a different ISP, perform the steps in the following section.

 **NOTE:** If you cannot connect to the Internet but have successfully connected in the past, the ISP might have a service outage. Contact your ISP to check the service status, or try connecting again later.

 **NOTE:** Have your ISP information ready. If you do not have an ISP, the Connect to the Internet wizard can help you get one.

1. Save and close any open files, and exit any open programs.
2. Click **Start**  → **Control Panel**.
3. Under **Network and Internet**, click **Connect to the Internet**.

The **Connect to the Internet** window appears.

4. Click either **Broadband (PPPoE)** or **Dial-up**, depending on how you want to connect:
 - a. Choose **Broadband** if you will use a DSL, satellite modem, cable TV modem, or Bluetooth® wireless technology connection.
 - b. Chose **Dial-up** if you will use an optional USB dial-up modem or ISDN.
-  **NOTE:** If you do not know which type of connection to select, click **Help me choose** or contact your ISP.
5. Follow the instructions on the screen and use the setup information provided by your ISP to complete the setup.



Using Your Inspiron Laptop

Your Inspiron 1318 has several indicators, buttons, and features that provide information at-a-glance and time-saving shortcuts for common tasks.

Device Status Lights

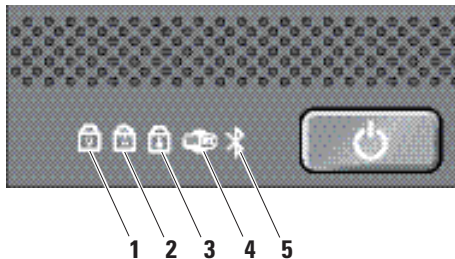
The device status lights located to the left of the power button provide information for wireless communication and keyboard input options.



- 1  **Num Lock light** – Turns on when the numeric keypad (**Num Lock** key) is enabled.
- 2  **Caps Lock light** – Turns on when the uppercase letter (**Caps Lock** key) is enabled.
- 3  **Scroll Lock light** – Turns on when the scroll lock function is enabled.

- 4  **WiFi status light** – Turns on when wireless networking is enabled. Use the wireless switch located at the front, right side of the computer to quickly turn all wireless communication On and Off.

Using The Wireless Switch

To turn on the wireless switch, slide it away from the front of the computer until it clicks into place.





- 5  **Bluetooth® status light (optional)** – Turns on when a card with Bluetooth wireless technology is enabled.

 **NOTE:** The card with Bluetooth wireless technology is an optional feature.

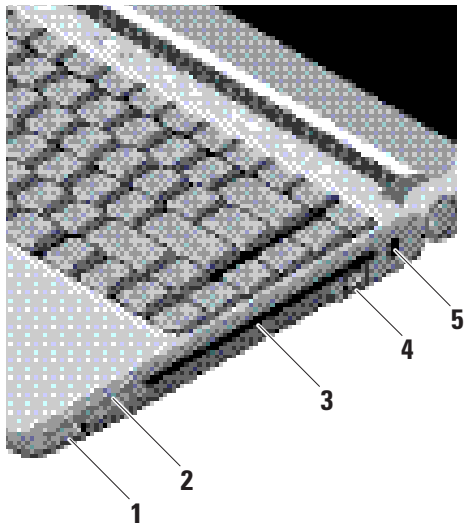

To turn off Bluetooth wireless, right-click the bluetooth icon in the notification area of your desktop, and click **Disable Bluetooth Radio** or use the wireless switch.

Right Side Features



-  **Wireless On/Off switch** – Use this switch to rapidly turn all wireless devices Off or On such as WLAN cards and internal cards with Bluetooth wireless technology. The wireless switch may be in the Off position when your computer is shipped to you. To turn the switch On, slide the switch away from the front of the computer until it clicks into place.



-  **NOTE:** This switch can be deactivated through Dell QuickSet or the BIOS (system setup program).
-  **ExpressCard slot** – Supports one ExpressCard. The computer ships with a plastic *blank* installed in the slot.

- 3 Optical Drive** – Plays or burns only standard-size and shape (12 cm) CDs, and DVDs. Ensure that the side with print or writing is facing upward when inserting discs.

 **NOTE:** Do not use non-standard-size or shape discs (including mini-CDs and mini-DVDs) or you will damage the drive.

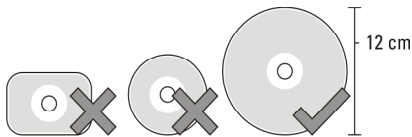





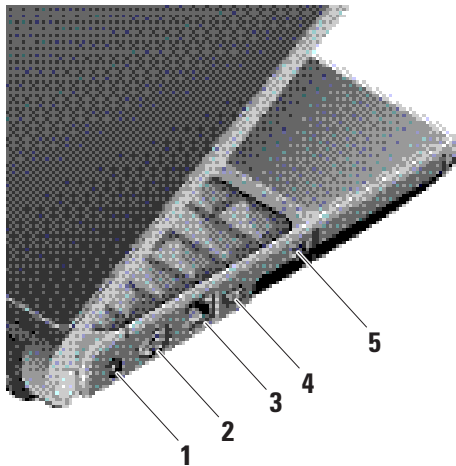

- 4  USB 2.0 connector** – Connects a USB device, such as a mouse, keyboard, printer, external drive, or MP3 player.

- 5 Security cable slot** – Used to attach a commercially available antitheft device to the computer.

 **NOTE:** Before you buy an antitheft device, ensure that it works with the security cable slot on your computer.



Left Side Features

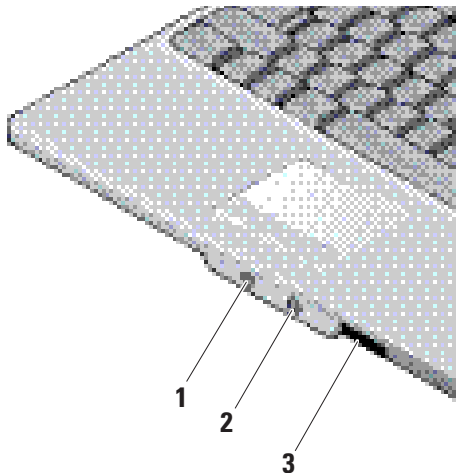

-  **AC adapter connector** – Connects to the AC adapter to power the computer and charge the battery when the computer is not in use.
-  **VGA connector** – Connects to a monitor or projector.
-  **Network connector** – If you are using a cabled network signal, this connects your computer to a network or broadband device.
-  **USB connector** – Connects to a USB device, such as a mouse, keyboard, printer, external drive, or MP3 player.
-  **IEEE 1394 connector** – Connects to high-speed serial multimedia devices, such as digital video cameras.

Front Side Features



-  **Audio Out/ Headphone connector** – Connects one pair of headphones, or sends audio to a powered speaker or sound system.
-  **Audio In/ Microphone connector** – Connects to a microphone or input signal for use with audio programs.
-  **8-in-1 Media card reader** – Provides a fast and convenient way to view and share digital photos, music, videos, and documents stored on the following digital memory cards:
 - Secure digital (SD) memory card
 - SDHC (Secure Digital High Capacity) card
 - Multi Media Card (MMC)
 - Memory Stick
 - Memory Stick PRO
 - xD-Picture Card (type - M and type - H)

Computer Base and Keyboard Features

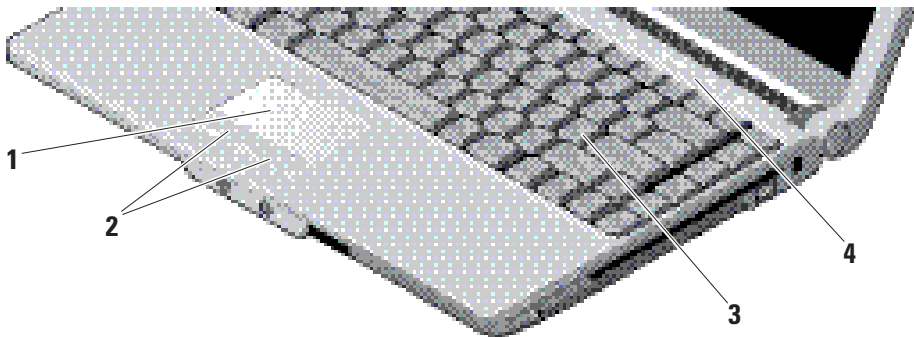

1 Touch pad – Provides the functionality of a mouse to move the cursor, drag or move selected items, and left-click by tapping the surface.

2 Touch pad buttons – Provide left- and right-click functions those on like a mouse.

3 Keyboard – The settings for this keyboard can be personalized by using Dell QuickSet. For more information, see the Dell Technology Guide.

4 Media Controls – Controls CD, DVD, and media playback.

Media Controls

To use the media controls, lightly touch the symbol and then release. The control's symbol will shine for 2 seconds to confirm your selection then fade away.

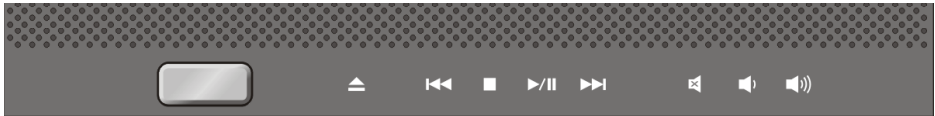

Eject the disc



Play the previous track or chapter



Stop



Play or pause



Play the next track or chapter



Mute the sound



Turn down the volume



Turn up the volume

Display Features

The display panel holds an optional camera and accompanying dual microphones.

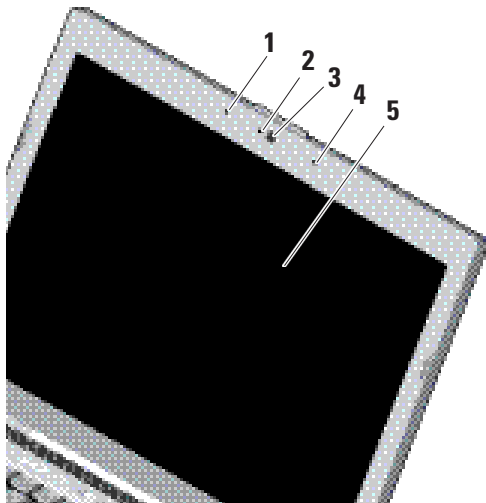

- 1 Left digital array microphone (optional)** – Combines with the right digital array microphone to provide high quality sound for video chatting and voice recording.
- 2 Camera activity indicator (optional)** – Light that indicates when the camera is on an off. Based on selections you made when purchasing your computer, your computer may not include a camera.
- 3 Camera (optional)** – Built-in camera for video capture, conferencing, and chat. Based the on selections you made when purchasing your computer, your computer may not include a camera.
- 4 Right digital array microphone (optional)** – Combines with the left digital array microphone to provide high quality sound for video chatting and voice recording.
- 5 Display** – Your display can vary based on selections you made when purchasing your computer. For more information about displays, see the *Dell Technology Guide*.

Removing and Replacing the Battery

⚠ CAUTION: Using an incompatible battery may increase the risk of fire or explosion. This computer should only use a battery purchased from Dell. Do not use batteries from other computers.

⚠ CAUTION: Before removing the battery, shut down the computer, and remove external cables (including the AC adapter).

To remove the battery:

1. Shut down the computer and turn it over.
2. Slide the battery release latch until it clicks into place.
3. Slide the battery out.

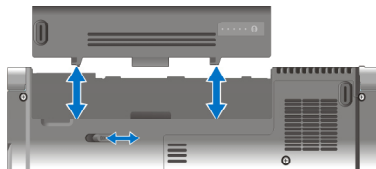

To replace the battery, slide it into the bay until it clicks into place.

Using the Optical Disc Drive

NOTICE: Do not use non-standard-size or shape discs (including mini-CDs and mini-DVDs) or you will damage the drive.

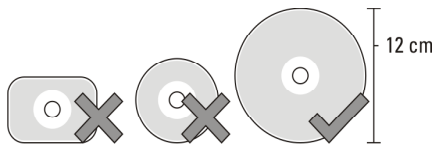

NOTE: Do not move the computer while playing or recording CDs and DVDs.

Place the disc in the center of the disc slot, with the label facing upwards and gently push the disc into the slot. The drive will automatically pull the disc in and begin reading its content.



 To eject a disc from the drive, gently touch the eject control. The control will flash to confirm a few seconds before ejecting the disc.

Software Features

 **NOTE:** For more information about the features described in this section, see the *Dell Technology Guide* on your hard drive or on the Dell Support website at support.dell.com.

Productivity and Communication

You can use your computer to create presentations, brochures, greeting cards, fliers, and spreadsheets. You can also edit and view digital photographs and images. Check your purchase order for software installed on your computer.

After connecting to the Internet, you can access websites, setup an e-mail account, upload and download files, and so on.

Entertainment and Multimedia

You can use your computer to watch videos, play games, create your own CDs, listen to music and internet radio stations. Your optical disc drive may support multiple disc media formats including CDs and DVDs.

You can download or copy pictures and video files from portable devices, such as digital cameras and cell phones. Optional software applications enable you to organize and create music and video files that can be recorded to disc, saved on portable products such as MP3 players and handheld entertainment devices, or played and viewed directly on connected TVs, projectors, and home theater equipment.

Customizing the Desktop

You can customize your desktop to change the appearance, resolution, wallpaper, screensaver, and so on by accessing the **Personalize appearance and sounds** window.

To access the display properties window:

1. Right-click an open area of the desktop.
2. Click **Personalize**, to open the **Personalize appearance and sounds** window and learn more about your customization options.

Customizing Your Energy Settings

You can use the power options in your operating system to configure the power settings on your computer. Microsoft® Windows Vista® provides three default options:

- **Balanced** — This power option offers full performance when you need it and saves power during periods of inactivity.
- **Power saver** — This power option saves power on your computer by reducing system performance to maximize the life of the computer and by reducing the amount of energy consumed by your computer over its lifetime.
- **High performance** — This power option provides the highest level of system performance on your computer by adapting processor speed to your activity and by maximizing system performance.

Backing Up Your Data

It is recommended that you periodically back up files and folders on your computer. To back up files:

1. Click **Start**  → **Control Panel** → **System and Maintenance** → **Welcome Center** → **Transfer files and settings**.
2. Click **Back up files** or **Back up computer**.
3. Click **Continue on Your User Account Control** dialog box and follow the instructions in the Back up Files wizard.

Solving Problems

⚠ CAUTION: Only trained service personnel should remove the computer cover. See the *Service Manual* on the Dell Support website at support.dell.com for advanced service and troubleshooting instructions.

If you can not solve your problem using the following guidelines, see “Using Support Tools” on page 31 or “Contacting Dell” on page 46.

Network Problems

Wireless Connections

If the network connection is lost —

The wireless switch may be off. To turn on the wireless switch, slide it from the rear to the front of the computer until it clicks into place.



The wireless router is offline or wireless has been disabled on the computer.

- Check your wireless router to ensure it is powered on and connected to your data source (cable modem or network hub).
- Re-establish your connection to the wireless router:
 - a. Save and close any open files, and exit any open programs.
 - b. Click **Start**  → **Connect To**.
 - c. Follow the instructions on the screen to complete the setup.

Solving Problems

Wired Connections

If the network connection is lost —

The network cable is loose or damaged.

- Check the cable to ensure it is plugged in and not damaged.

The link integrity light on the integrated network connector lets you verify that your connection is working and provides information on the status:

- Green — A good connection exists between a 10-Mbps network and the computer.
- Orange — A good connection exists between a 100-Mbps network and the computer.
- Yellow — A good connection exists between a 1000-Mbps network and the computer.
- Off — The computer is not detecting a physical connection to the network.

 **NOTE:** The link integrity light on the network connector is only for the wired cable connection. The link integrity light does not provide status for wireless connections.

Power Problems

If the power light is off — The computer is either turned off or is not receiving power.

- Reseat the power cable into both the power connector on the computer and the electrical outlet.
- If the computer is plugged into a power strip, ensure that the power strip is plugged into an electrical outlet and that the power strip is turned on. Also temporarily bypass power protection devices, power strips, and power extension cables to verify that the computer turns on properly.
- Ensure that the electrical outlet is working by testing it with another device, such as a lamp.
- Check the AC adapter cable connections. If the AC adapter has a light, ensure that the light on the AC adapter is on.

If the power light is solid white and the computer is not responding — The display may not be connected or powered on. Ensure that the display is properly connected and then turn it off then back on.

If the power light is blinking white — The computer is in standby mode. Press a key on the keyboard, move the pointer on the trackpad or a connected mouse, or press the power button to resume normal operation.

If the power light is solid amber — The computer has a power problem or an internal device malfunction. For assistance contact Dell, see “Contacting Dell” on page 46.

If the power light is blinking amber — The computer is receiving electrical power, but a device might be malfunctioning or incorrectly installed. You may have to remove and then reinstall the memory modules (for information on removing and replacing memory modules, see the *Service Manual* on the Dell Support website at support.dell.com).

If you encounter interference that hinders reception on your computer — An unwanted signal is creating interference by interrupting or blocking other signals. Some possible causes of interference are:

- Power, keyboard, and mouse extension cables.
- Too many devices connected to a power strip.
- Multiple power strips connected to the same electrical outlet.

Memory Problems

If you receive an insufficient memory message—

- Save and close any open files and exit any open programs you are not using to see if that resolves the problem.
- See the software documentation for minimum memory requirements. If necessary, install additional memory (See the *Service Manual* on the Dell Support website at support.dell.com).

Solving Problems

- Reseat the memory modules (See the *Service Manual* on the Dell Support website at support.dell.com) to ensure that your computer is successfully communicating with the memory.

If you experience other memory problems —

- Ensure that you are following the memory installation guidelines (see the *Service Manual* on the Dell Support website at support.dell.com).
- Check if the memory module is compatible with your computer. Your computer supports DDR2 memory. For more information about the type of memory supported by your computer, see “Basic Specifications” on page 50.
- Run the Dell Diagnostics (see “Dell Diagnostics” on page 33).
- Reseat the memory modules (see the *Service Manual* on the Dell Support website at support.dell.com) to ensure that your computer is successfully communicating with the memory.

Lockups and Software Problems

If the computer does not start up — Ensure that the power cable is firmly connected to the computer and to the electrical outlet.

If a program stops responding — End the program:

1. Press <Ctrl><Shift><Esc> simultaneously.
2. Click **Applications**.
3. Click the program that is no longer responding
4. Click **End Task**.

If a program crashes repeatedly — Check the software documentation. If necessary, uninstall and then reinstall the program.

 **NOTE:** Software usually includes installation instructions in its documentation or on CD.

If the computer stops responding —

 **NOTICE:** You might lose data if you are unable to perform an operating system shutdown.

Turn the computer off. If you are unable to get a response by pressing a key on your keyboard or moving your mouse, press and hold the power button for at least 8 to 10 seconds until the computer turns off. Then restart your computer.

If a program is designed for an earlier Microsoft® Windows® operating system —

Run the Program Compatibility Wizard. The Program Compatibility Wizard configures a program so that it runs in an environment similar to non-Windows Vista operating system environments.

1. Click **Start**  → **Control Panel** → **Programs** → **Use an older program with this version of Windows.**
2. In the welcome screen, click **Next**.
3. Follow the instructions on the screen.

If a solid blue screen appears — Turn the computer off. If you are unable to get a response by pressing a key on your keyboard or moving your pointer or mouse, press and hold the power button for at least 8 to 10 seconds until the computer turns off. Then restart your computer.

If you have other software problems —

- Back up your files immediately.
- Use a virus-scanning program to check the hard drive or CDs.
- Save and close any open files or programs and shut down your computer through the **Start**  menu.
- Check the software documentation or contact the software manufacturer for troubleshooting information:
 - Ensure that the program is compatible with the operating system installed on your computer.

Solving Problems

- Ensure that your computer meets the minimum hardware requirements needed to run the software. See the software documentation for information.
- Ensure that the program is installed and configured properly.
- Verify that the device drivers do not conflict with the program.
- If necessary, uninstall and then reinstall the program. Dell Support Center

Using Support Tools

Dell Support Center

The Dell Support Center helps you find the service, support, and system-specific information you need. For more information about Dell Support Center and available support tools, click the **Services** tab at **support.dell.com**.



Click the  icon in the taskbar to run the application. The home page provides links to access:

- Self Help (Troubleshooting, Security, System Performance, Network/Internet, Backup/Recovery, and Windows Vista)
- Alerts (technical support alerts relevant to your computer)

- Assistance from Dell (Technical Support with DellConnect™, Customer Service, Training and Tutorials, How-To Help with Dell on Call, and Online Scan with PCCheckUp)
- About Your System (System Documentation, Warranty Information, System Information, Upgrades & Accessories)

The top of the Dell Support Center home page displays your system's model number along with its service tag and express service code.

For more information about the Dell Support Center, see the *Dell Technology Guide* on your hard drive or on the Dell Support website at **support.dell.com**.

System Messages

If your computer has an issue or error, it may display a System Message that will help you identify the cause and action needed to resolve the issue.

 **NOTE:** If the message you received is not listed in the following examples, see the documentation for either the operating system or the program that was running when the message appeared. Or see “Contacting Dell” on page 46 for assistance.

Alert! Previous attempts at booting this system have failed at checkpoint [nnnn]. For help in resolving this problem, please note this checkpoint and contact Dell Technical Support —

The computer failed to complete the boot routine three consecutive times for the same error see “Contacting Dell” on page 46 for assistance.

CMOS checksum error — Possible motherboard failure or RTC battery low. Replace the battery. See the *Service Manual* on the Dell Support website at support.dell.com or see “Contacting Dell” on page 46 for assistance.

CPU fan failure — CPU fan has failed. Replace the CPU fan. See the *Service Manual* on the Dell Support website at support.dell.com.

Hard-disk drive failure — Possible hard disk drive failure during HDD POST see “Contacting Dell” on page 46 for assistance.

Hard-disk drive read failure — Possible hard disk drive failure during HDD boot test see “Contacting Dell” on page 46 for assistance.

Keyboard failure — Keyboard failure or loose cable.

No boot device available — No bootable partition on hard disk drive, the hard disk drive cable is loose, or no bootable device exists.

- If the hard drive is your boot device, ensure that the cables are connected and that the drive is installed properly and partitioned as a boot device.
- Enter system setup and ensure that the boot sequence information is correct (see the *Service Manual* on the Dell Support website at support.dell.com).

No timer tick interrupt — A chip on the system board might be malfunctioning or motherboard failure (see the *Service Manual* on the Dell Support website at support.dell.com).

USB over current error — Disconnect the USB device. Your USB device needs more power for it to function properly. Use an external power source to connect the USB device, or if your device has two USB cables, connect both of them.

NOTICE - Hard Drive SELF MONITORING SYSTEM has reported that a parameter has exceeded its normal operating range. Dell recommends that you back up your data regularly. A parameter out of range may or may not indicate a potential hard drive problem — S.M.A.R.T error, possible hard disk drive failure. This feature can be enabled or disabled in the BIOS setup (see “Contacting Dell” on page 46 for assistance).

Hardware Troubleshooter

If a device is either not detected during the operating system setup or is detected but incorrectly configured, you can use the **Hardware Troubleshooter** to resolve the incompatibility.

To start the Hardware Troubleshooter:

1. Click **Start**  → **Help and Support**.
2. Type `hardware troubleshooter` in the search field and press <Enter> to start the search.
3. In the search results, select the option that best describes the problem and follow the remaining troubleshooting steps.

Dell Diagnostics

If you experience a problem with your computer, perform the checks in “Lockups and Software Problems” on page 28 and run the Dell Diagnostics before you contact Dell for technical assistance.

It is recommended that you print these procedures before you begin.

 **NOTICE:** Dell Diagnostics works only on Dell computers.

 **NOTE:** The *Drivers and Utilities* media is optional and may not ship with your computer.

See the System Setup section in the *Service Manual* to review your computer’s configuration information, and ensure that the device that you want to test displays in the system setup program and is active.

Start the Dell Diagnostics from your hard drive or from the *Drivers and Utilities* media.

Starting Dell Diagnostics From Your Hard Drive

The Dell Diagnostics is located on a hidden diagnostic utility partition on your hard drive.

 **NOTE:** If your computer cannot display a screen image, see “Contacting Dell” on page 46.

1. Ensure that the computer is connected to an electrical outlet that is known to be working properly.
2. Turn on (or restart) your computer.
3. When the DELL™ logo appears, press <F12> immediately. Select **Diagnostics** from the boot menu and press <Enter>.

 **NOTE:** If you wait too long and the operating system logo appears, continue to wait until you see the Microsoft® Windows® desktop; then, shut down your computer and try again.

 **NOTE:** If you see a message stating that no diagnostics utility partition has been found, run the Dell Diagnostics from the *Drivers and Utilities* media.

4. Press any key to start the Dell Diagnostics from the diagnostics utility partition on your hard drive.

Starting Dell Diagnostics From the Drivers and Utilities Media

1. Insert the *Drivers and Utilities* media.
2. Shut down and restart the computer.
When the DELL logo appears, press <F12> immediately.

 **NOTE:** If you wait too long and the operating system logo appears, continue to wait until you see the Microsoft® Windows® desktop; then, shut down your computer and try again.

 **NOTE:** The next steps change the boot sequence for one time only. On the next start-up, the computer boots according to the devices specified in the system setup program.

3. When the boot device list appears, highlight **CD/DVD/CD-RW** and press <Enter>.

4. Select the **Boot from CD-ROM** option from the menu that appears and press <Enter>.
5. Type 1 to start the CD menu and press <Enter> to proceed.
6. Select **Run the 32 Bit Dell Diagnostics** from the numbered list. If multiple versions are listed, select the version appropriate for your computer.
7. When the Dell Diagnostics **Main Menu** appears, select the test you want to run.

Restoring Your Operating System

You can restore your operating system in the following ways:

- System Restore returns your computer to an earlier operating state without affecting data files. Use System Restore as the first solution for restoring your operating system and preserving data files.
- Dell Factory Image Restore returns your hard drive to the operating state it was in when you purchased the computer. Both procedures permanently deletes all data on the hard drive and removes any programs installed after you received the computer. Use Dell Factory Image Restore only if System Restore did not resolve your operating system problem.
- If you received an Operating System disc with your computer, you can use it to restore your operating system. However, using the Operating System disc also deletes all data

on the hard drive. Use the disc only if System Restore did not resolve your operating system problem.

System Restore



The Windows operating systems provide a System Restore option which allows you to return your computer to an earlier operating state (without affecting data files) if changes to the hardware, software, or other system settings have left the computer in an undesirable operating state. Any changes that System Restore makes to your computer are completely reversible.



NOTICE: Make regular backups of your data files. System Restore does not monitor your data files or recover them.



-  **NOTE:** The procedures in this document were written for the Windows default view, so they may not apply if you set your Dell™ computer to the Windows Classic view.

Starting System Restore

1. Click **Start** .
 2. In the **Start Search** box, type `System Restore` and press <Enter>.
-  **NOTE:** The **User Account Control** window may appear. If you are an administrator on the computer, click **Continue**; otherwise, contact your administrator to continue the desired action.
3. Click **Next** and follow the remaining prompts on the screen.

In the event that System Restore did not resolve the issue, you may undo the last system restore.

Undoing the Last System Restore

-  **NOTE:** Before you undo the last system restore, save and close all open files and exit any open programs. Do not alter, open, or delete any files or programs until the system restoration is complete.
1. Click **Start** .
 2. In the **Start Search** box, type `System Restore` and press <Enter>.
 3. Click **Undo my last restoration** and click **Next**.

Dell Factory Image Restore

 **NOTICE:** Using Dell Factory Image Restore permanently deletes all data on the hard drive and removes any programs or drivers installed after you received your computer. If possible, back up the data before using these options. Use Dell Factory Image Restore only if System Restore did not resolve your operating system problem.

 **NOTE:** Dell Factory Image Restore may not be available in certain countries or on certain computers.

Use Dell Factory Image Restore only as the last method to restore your operating system. These options restore your hard drive to the operating state it was in when you purchased the computer. Any programs or files added since you received your computer—including data files—are permanently deleted from the hard drive. Data files include documents, spreadsheets, e-mail messages, digital photos,

music files, and so on. If possible, back up all data before using Factory Image Restore.

Dell Factory Image Restore

1. Turn on the computer. When the Dell logo appears, press <F8> several times to access the **Vista Advanced Boot Options** Window.
 2. Select **Repair Your Computer**.
 3. The **System Recovery Options** window appears.
 4. Select a keyboard layout and click **Next**.
 5. To access the recovery options, log on as a local user. To access the command prompt, type `administrator` in the **User name** field, then click **OK**.
 6. Click **Dell Factory Image Restore**. The **Dell Factory Image Restore** welcome screen appears.
-  **NOTE:** Depending upon your configuration, you may need to select **Dell Factory Tools**, then **Dell Factory Image Restore**.
7. Click **Next**. The **Confirm Data Deletion** screen appears.

 **NOTICE:** If you do not want to proceed with Factory Image Restore, click **Cancel**.

8. Click the checkbox to confirm that you want to continue reformatting the hard drive and restoring the system software to the factory condition, then click **Next**.

The restore process begins and may take five or more minutes to complete. A message appears when the operating system and factory-installed applications have been restored to factory condition.

9. Click **Finish** to reboot the system.

Operating System Reinstallation

Before you Begin

If you are considering reinstalling the Windows operating system to correct a problem with a newly installed driver, first try using Windows Device Driver Rollback. If Device Driver Rollback does not resolve the problem, then use System Restore to return your operating system to the operating state

it was in before you installed the new device driver. See “Using Microsoft Windows System Restore” on page 36.

 **NOTICE:** Before performing the installation, back up all data files on your primary hard drive. For conventional hard drive configurations, the primary hard drive is the first drive detected by the computer.

To reinstall Windows, you need the following items:

- *Dell Operating System* media
- *Dell Drivers and Utilities* media

 **NOTE:** The *Dell Drivers and Utilities* media contains drivers that were installed during the assembly of the computer. Use the Dell Drivers and Utilities media to load any required drivers. Depending on the region from which you ordered your computer, or whether you requested the media, the *Dell Drivers and Utilities* media and *Operating System* media may not ship with your computer.

Restoring Your Operating System

Reinstalling Windows Vista

The reinstallation process can take 1 to 2 hours to complete. After you reinstall the operating system, you must also reinstall the device drivers, virus protection program, and other software.

1. Save and close any open files and exit any open programs.
2. Insert the *Operating System* media.
3. Click **Exit** if the **Install Windows** message appears.
4. Restart the computer.
5. When the DELL logo appears, press <F12> immediately.

 **NOTE:** If you wait too long and the operating system logo appears, continue to wait until you see the Microsoft® Windows® desktop; then, shut down your computer and try again.

 **NOTE:** The next steps change the boot sequence for one time only. On the next start-up, the computer boots according to the devices specified in the system setup program.

6. When the boot device list appears, highlight **CD/DVD/CD-RW Drive** and press <Enter>.
7. Press any key to **Boot from CD-ROM**. Follow the instructions on the screen to complete the installation.

Getting Help

If you experience a problem with your computer, you can complete the following steps to diagnose and troubleshoot the problem:

1. See “Solving Problems” on page 25 for information and procedures that pertain to the problem your computer is experiencing.
2. See “Dell Diagnostics” on page 33 for procedures on how to run Dell Diagnostics.
3. Fill out the “Diagnostic Checklist” on page 45.
4. Use Dell’s extensive suite of online services available at Dell Support (support.dell.com) for help with installation and troubleshooting procedures. See “Online Services” on page 42 for a more extensive list of Dell Support online.
5. If the preceding steps have not resolved the problem, see “Contacting Dell” on page 46.

 **NOTE:** Call Dell Support from a telephone near or at the computer so that the support staff can assist you with any necessary procedures.

 **NOTE:** Dell’s Express Service Code system may not be available in all countries.

When prompted by Dell’s automated telephone system, enter your Express Service Code to route the call directly to the proper support personnel. If you do not have an Express Service Code, open the **Dell Accessories** folder, double-click the **Express Service Code** icon, and follow the directions.

 **NOTE:** Some of the following services are not always available in all locations outside the continental U.S. Call your local Dell representative for information on availability.

Technical Support and Customer Service

Dell's support service is available to answer your questions about Dell hardware. Our support staff uses computer-based diagnostics to provide fast, accurate answers.

To contact Dell's support service, see "Before You Call" on page 45 and then see the contact information for your region or go to support.dell.com.

DellConnect™

DellConnect is a simple online access tool that allows a Dell service and support associate to access your computer through a broadband connection, diagnose your problem and repair it all under your supervision. For more information, go to support.dell.com and click **DellConnect**.

Online Services

You can learn about Dell products and services on the following websites:

- www.dell.com
- www.dell.com/ap (Asian/Pacific countries only)
- www.dell.com/jp (Japan only)
- www.euro.dell.com (Europe only)
- www.dell.com/la (Latin American and Caribbean countries)
- www.dell.ca (Canada only)

You can access Dell Support through the following websites and e-mail addresses:

Dell Support websites

- support.dell.com
- support.jp.dell.com (Japan only)
- support.euro.dell.com (Europe only)

Dell Support e-mail addresses

- **mobile_support@us.dell.com**
- **support@us.dell.com**
- **la-techsupport@dell.com** (Latin America and Caribbean countries only)
- **apsupport@dell.com** (Asian/Pacific countries only)

Dell Marketing and Sales e-mail addresses

- **apmarketing@dell.com** (Asian/Pacific countries only)
- **sales_canada@dell.com** (Canada only)

Anonymous file transfer protocol (FTP)

- **ftp.dell.com**

Log in as user: *anonymous*, and use your e-mail address as your password.

AutoTech Service

Dell's automated support service—AutoTech—provides recorded answers to the questions most frequently asked by Dell customers about their portable and desktop computers.

When you call AutoTech, use your touch-tone telephone to select the subjects that correspond to your questions. For instructions on accessing the telephone number to call your region, see “Contacting Dell” on page 46.

Automated Order-Status Service

To check on the status of any Dell products that you have ordered, you can go to **support.dell.com**, or you can call the automated order-status service. A recording prompts you for the information needed to locate and report on your order. For the telephone number to call your region, see “Contacting Dell” on page 46 for problems with your order.

If you have a problem with your order, such as missing parts, wrong parts, or incorrect billing, contact Dell for customer assistance. Have your invoice or packing slip handy when you call. For the telephone number to call for your region, see “Contacting Dell” on page 46.

Product Information

If you need information about additional products available from Dell, or if you would like to place an order, visit the Dell website at **www.dell.com**. For the telephone number to call for your region or to speak to a sales specialist, see “Contacting Dell” on page 46.

Returning Items for Repair Under Warranty or for Credit

Prepare all items being returned, whether for repair or credit, as follows:

1. Call Dell to obtain a Return Material Authorization Number, and write it clearly and prominently on the outside of the box.
2. For the telephone number to call for your region, see “Contacting Dell” on page 46.
3. Include a copy of the invoice and a letter describing the reason for the return.
4. Include a copy of the Diagnostics Checklist (see “Diagnostic Checklist” on page 45), indicating the tests that you have run and any error messages reported by the Dell Diagnostics (see “Dell Diagnostics” on page 33).
5. Include any accessories that belong with the item(s) being returned (power cables, software, guides, and so on) if the return is for credit.
6. Pack the equipment to be returned in the original (or equivalent) packing materials.
7. You are responsible for paying shipping expenses. You are also responsible for insuring any product returned, and you assume the risk of loss during shipment to Dell. Collect On Delivery (C.O.D.) packages are not accepted.
8. Returns that are missing any of the preceding requirements will be refused at Dell’s receiving dock and returned to you.

Before You Call

 **NOTE:** Have your Express Service Code ready when you call. The code helps Dell's automated-support telephone system direct your call more efficiently. You may also be asked for your Service Tag (located on the back or bottom of your computer).

Remember to fill out the following Diagnostics Checklist. If possible, turn on your computer before you call Dell for assistance and call from a telephone at or near the computer. You may be asked to type some commands at the keyboard, relay detailed information during operations, or try other troubleshooting steps possible only at the computer itself. Ensure that the computer documentation is available.

Diagnostic Checklist

- Name:
- Date:
- Address:
- Phone number:
- Service Tag (bar code on the back or bottom of the computer):
- Express Service Code:
- Return Material Authorization Number (if provided by Dell support technician):
- Operating system and version:
- Devices:
- Expansion cards:
- Are you connected to a network? Yes /No
- Network, version, and network adapter:
- Programs and versions:

Getting Help

See your operating system documentation to determine the contents of the computer's start-up files. If the computer is connected to a printer, print each file. Otherwise, record the contents of each file before calling Dell.

- Error message, beep code, or diagnostic code:
- Description of problem and troubleshooting procedures you performed:

Contacting Dell

For customers in the United States, call 800-WWW-DELL (800-999-3355).

 **NOTE:** If you do not have an active Internet connection, you can find contact information on your purchase invoice, packing slip, bill, or Dell product catalog.

Dell provides several online and telephone-based support and service options. Availability varies by country and product, and some services may not be available in your area.

To contact Dell for sales, technical support, or customer service issues:

1. Visit **support.dell.com**.
2. Verify your country or region in the **Choose A Country/Region** drop-down menu at the bottom of the page.
3. Click **Contact Us** on the left side of the page.
4. Select the appropriate service or support link based on your need.
5. Choose the method of contacting Dell that is convenient for you.

Finding More Information and Resources

If you need to:**See:**

reinstall your operating system.

your Operating System media.

run a diagnostic program for your computer, reinstall Notebook System Software (NSS), or update drivers for your computer, and readme files.

the *Drivers and Utilities* media.



NOTE: Drivers and documentation updates can be found on the Dell™ Support website at **support.dell.com**.

learn more about your operating system, maintaining peripherals, RAID, Internet, Bluetooth®, networking, and e-mail.

the *Dell Technology Guide* installed on your hard drive.

upgrade your computer with new or additional memory, or a new hard drive.

the *Service Manual* on the Dell Support website at **support.dell.com**.

reinstall or replace a worn or defective part.



NOTE: In some countries, opening and replacing parts of your computer may void your warranty. Check your warranty and return policies before working inside your computer.

If you need to:

find safety best practices information for your computer.

review Warranty information, Terms and Conditions (U.S. only), Safety instructions, Regulatory information, Ergonomics information, and End User License Agreement.

find your Service tag/Express Service Code— You must use the service tag to identify your computer on **support.dell.com** or to contact technical support.

find drivers and downloads.
access technical support and product help.
check on your order status for new purchases.
find solutions and answers to common questions.
locate information for last-minute updates about technical changes to your computer or advanced technical-reference material for technicians or experienced users.

See:

the safety and regulatory documents that shipped with your computer and also see the Regulatory Compliance Homepage at: **www.dell.com/regulatory_compliance.**

the back or bottom of your computer.



the Dell™ Support website at **support.dell.com.**

Basic Specifications

System Model

Dell Inspiron 1318

This section provides basic information that you may need when setting up, updating drivers for, and upgrading your computer.

 **NOTE:** Offerings may vary by region. For more information regarding the configuration of your computer, click **Start**  → **Help and Support** and select the option to view information about your computer.

Processor

Types	Intel® Core™2 Duo Intel® Celeron® Intel® Celeron® Dual-Core Intel® Pentium™ Dual-Core
L2 cache	512 KB, 1 MB, 2 MB or 4 MB per core
External bus frequency	533 MHz, 667 MHz or 800 MHz

Express Card

ExpressCard controller	Mobile Intel Express (GM 965 or PM 965)
ExpressCard connector	one ExpressCard slot (54 mm)

Express Card

Cards supported	ExpressCard/34 (34 mm) ExpressCard/54 (54 mm) 1.5 V and 3.3 V
ExpressCard connector size	26 pins

Memory

Connectors	two internally-accessible SO-DIMM sockets
Capacities	512 MB, 1 GB, and 2 GB
Memory type	667 MHz and 800 MHz DDR2 SODIMM
Memory configuration possible	1 GB, 1.5 GB, 2 GB, 3 GB, 4 GB



NOTE: For instructions on upgrading your memory, see the *Service Manual* on the Dell Support website at support.dell.com.

Computer Information

System Chipset	Mobile Intel Express (GM 965 or PM 965)
Data bus width	64 bits
DRAM bus width	dual channel (2) 64-bit buses
Processor address bus width	32 bits
Flash EPROM	2 MB
Graphics bus	PCI -E X16
PCI Bus	32 bits

Basic Specifications

Communications

Modem type	External V.92 56K USB Modem
Modem controller	Hardware Modem
Modem interface	Universal Serial Bus (USB)
Network adapter	10/100/1000 Ethernet LAN on system board
Wireless	internal WLAN (Mini-Card), Bluetooth® wireless technology

Video

Video type	integrated on system board
Video controller	Intel 965 GM
Video memory	Up to 384 MB of system memory
LCD interface	LVDS

Video

Video type	discrete video card
Video controller	nVIDIA GeForce 8400M GS
Video memory	128 MB GeForce 8400M GS
LCD interface	LVDS

Camera (optional)

Pixel	2.0 megapixel
Video resolution	320x240 ~1600x1200 (640x480 at 30fps)
Diagonal viewing angle	66°

Audio

Audio type	2 channel High Definition Audio
Audio controller	IDT STAC9228
Stereo conversion	24-bit (analog-to-digital and digital-to-analog)
Internal Interface	Intel High Definition Audio
External Interface	microphone-in connector, stereo headphone/speaker connector
Speaker	two 4-ohm speakers
Internal speaker amplifier	2 watt per channel into 4 ohms
Volume controls	program menus, media control buttons

Ports and Connectors

Audio	microphone connector, one stereo headphone/speakers connector
IEEE 1394a	4-pin serial connector
Mini-Card	one Type IIIA Mini Card slot
Network adapter	RJ-45 port
USB	two 4-pin USB 2.0-compliant connectors
Video	15-hole connector

Basic Specifications

Display

Type (TrueLife)	13.3-inch WXGA TrueLife
<i>Dimensions:</i>	
Height	286.08 mm (11.26 in)
Width	178.8 mm (7.03 in)
Diagonal	337.8 mm (13.29 in)
Maximum resolution	1280 x 800
Refresh rate	60 Hz
Operating angle	0° (closed) to 140°
Luminance	200 min. 220 typ. cd/m ² (CCFL 5 point avg)

Display

<i>Viewing Angles:</i>	
Horizontal	±40° (CCFL) min.
Vertical	+15°/-30° (CCFL) min.
Pixel pitch	0.2235 mm
Controls	brightness can be controlled through keyboard shortcuts (see <i>Dell Technology Guide</i> for more information.)

Keyboard

Number of keys	86/103 (U.S. and Canada); 87/104 (Europe); 90/107 (Japan)
Layout	QWERTY/AZERTY/Kanji

Touchpad

X/Y position resolution (graphics table mode)	240 cpi
<i>Size:</i>	
Width	63.1 mm (2.48 in) sensor-active area
Height	37.1 mm (1.46 in) rectangle

Battery

Type	4-cell/6-cell/9-cell "smart" lithium ion
Depth	64.2 mm (2.52 inches) (9 cell) 51.6 mm (2.03 inches) (4, 6 cell)
Height	41.9 mm (1.64 in) (9 cell) 29.5 mm (1.16 in) (4/6 cell)

Battery

Width	276.5 mm (10.8 in) (9 cell) 206.4 mm (8.12 in) (4/6 cell)
Weight	0.53 kg (1.17 lb) (9 cell) 0.37 kg (0.82 lb) (6 cell) 0.26 kg (0.57 lb) (4 cell)
Voltage	11.1 VDC (6,9 cell) 14.8 VDC (4 cell)
Charge time (approximate): Computer off	4 hours
Operating time	Battery operating time varies depending on operating conditions and can be significantly reduced under certain power-intensive conditions. <i>See Dell Technology Guide for more information.</i>

Basic Specifications

Battery

Life span 300 discharge/charge cycles
(approximate)

Temperature range:

Operating 0° to 35°C (32° to 95°F)

Storage -40° to 65°C (-40° to 149°F)

Coin-cell
battery CR-2032

AC Adapter

Input voltage 100–240 VAC

Input current 1.5 A/1.6 A
(maximum)

Input frequency 50–60 Hz

Output power 65 W or 90 W

AC Adapter

Output current 5.62 A (maximum at
90 W) 4-second pulse)
4.62 A (continuous)

Output current 3.9 A (maximum at
65 W) 4-second pulse)
3.34 A (continuous)

Rated output
voltage 19.5 +/- 1 VDC

Dimensions:

65 W

Height 29.0 mm (1.14 in)

Width 46.2 mm (1.83 in)

Depth 107.0 mm (4.21 in)

Weight
(with cables) 0.25 kg (0.55 lb)

AC Adapter

90 W (D Series)

Height 34.2 mm (1.35 in)

Width 60.8 mm (2.39 in)

Depth 153.42 mm (6.04 in)

Weight (with
cables) 0.46 kg (1.01 lb)*Temperature
range*

Operating 0° to 35°C (32° to 95°F)

Storage -40° to 65°C (-40° to 149°F)

PhysicalHeight 25.4 mm to 38.37 mm (1 in to
1.51 in)

Width 318 mm (12.55 in)

Depth 238 mm (9.37 in)

Weight (with
4-cell battery):

Configurable to less than 2.14 kg (4.72 lb)

Computer Environment*Temperature range:*Operating 0° to 35°C (32° to
95°F)Storage -40° to 65°C (-40° to
149°F)

Basic Specifications

Computer Environment

Relative humidity (maximum):

Operating	10% to 90% (noncondensing)
-----------	-------------------------------

Storage	5% to 95% (noncondensing)
---------	------------------------------

Maximum vibration (using a random-vibration spectrum that simulates user environment):

Operating	0.66 GRMS
-----------	-----------

Storage	1.3 GRMS
---------	----------

Maximum shock (measured with hard drive in head-parked position and a 2-ms half-sine pulse):

Operating	110 G
-----------	-------

Storage	163 G
---------	-------

Computer Environment

Altitude (maximum):

Operating	-15.2 to 3048 m (-50 to 10,000 ft)
-----------	---------------------------------------

Storage	-15.2 to 10,668 m (-50 to 35,000 ft)
---------	---

Airborne contaminant level	G2 or lower as defined by ISA-S71.04-1985
----------------------------	---

Index

A

- AC adapter
 - size and weight **56, 57**
- airflow, allowing **5**
- AutoTech **43**

B

- backups
 - creating **24**

C

- calling Dell **45**
- CDs, playing and creating **23**
- chipset **51**
- computer capabilities **23**
- computer, setting up **5**

- connect(ing)
 - to the Internet **8**
 - using dial-up **9**
 - via DSL **9**
 - via WLAN **9**
- conserving energy **24**
- Contacting Dell online **46**
- customer service **42**
- customizing
 - your desktop **23**
 - your energy settings **24**

D

- damage, avoiding **5**
- data, backing up **24**
- DellConnect **42**
- Dell Diagnostics **34**

Index

Dell Factory Image Restore **36**

Dell Support Center **31**

Dell support website **49**

Dell Technology Guide

for further information **48**

Diagnostic Checklist **45**

disc drive

supported disc sizes **22**

discs

ejecting **22**

using **22**

drivers and downloads **49**

DVDs, playing and creating **23**

E

email addresses

for technical support **43**

energy

conserving **24**

expansion bus **52**

60

F

finding more information **48**

FTP login, anonymous **43**

H

hardware problems

diagnosing **33**

Hardware Troubleshooter **33**

help

getting assistance and support **41**

I

Internet connection **8**

ISP

Internet Service Provider **8**

M

memory problems

solving **28**

memory support **51**

Microsoft™ Windows Vista® **8**

N

- network connection
 - fixing **26**
- network speed
 - testing **25**

O

- order status **43**

P

- power problems, solving **26**
- power strips, using **6**
- problems, solving **25**
- processor **50**
- products
 - information and purchasing **44**

R

- reinstalling Windows **36**
- resources, finding more **48**
- restoring factory image **38**

S

- setup, before you begin **5**
- shipping products
 - for return or repair **44**
- software features **23**
- software problems **28**
- solving problems **25**
- specifications **50**
- support email addresses **43**
- support sites
 - worldwide **42**
- System Messages **32**
- system reinstall options **36**
- System Restore **36**

Index

T

technical support **42**

V

ventilation, ensuring **5**

W

warranty returns **44**

Windows, reinstalling **36**

Windows Vista®

- Program Compatibility Wizard **29**

- reinstalling **40**

- setup **8**

wired network

- network cable, connecting **7**

wireless network connection **25**

wireless switch **6, 13, 25**



Printed in the U.S.A.

www.dell.com | support.dell.com



0N073FA01

Printed in China.

Printed on recycled paper.

www.dell.com | support.dell.com



0N073FA01

Printed in Malaysia.

www.dell.com | support.dell.com



0N073FA01

Printed in Ireland.

www.dell.com | support.dell.com



0N073FA01

Printed in Brazil.

www.dell.com | support.dell.com



0N073FA01